

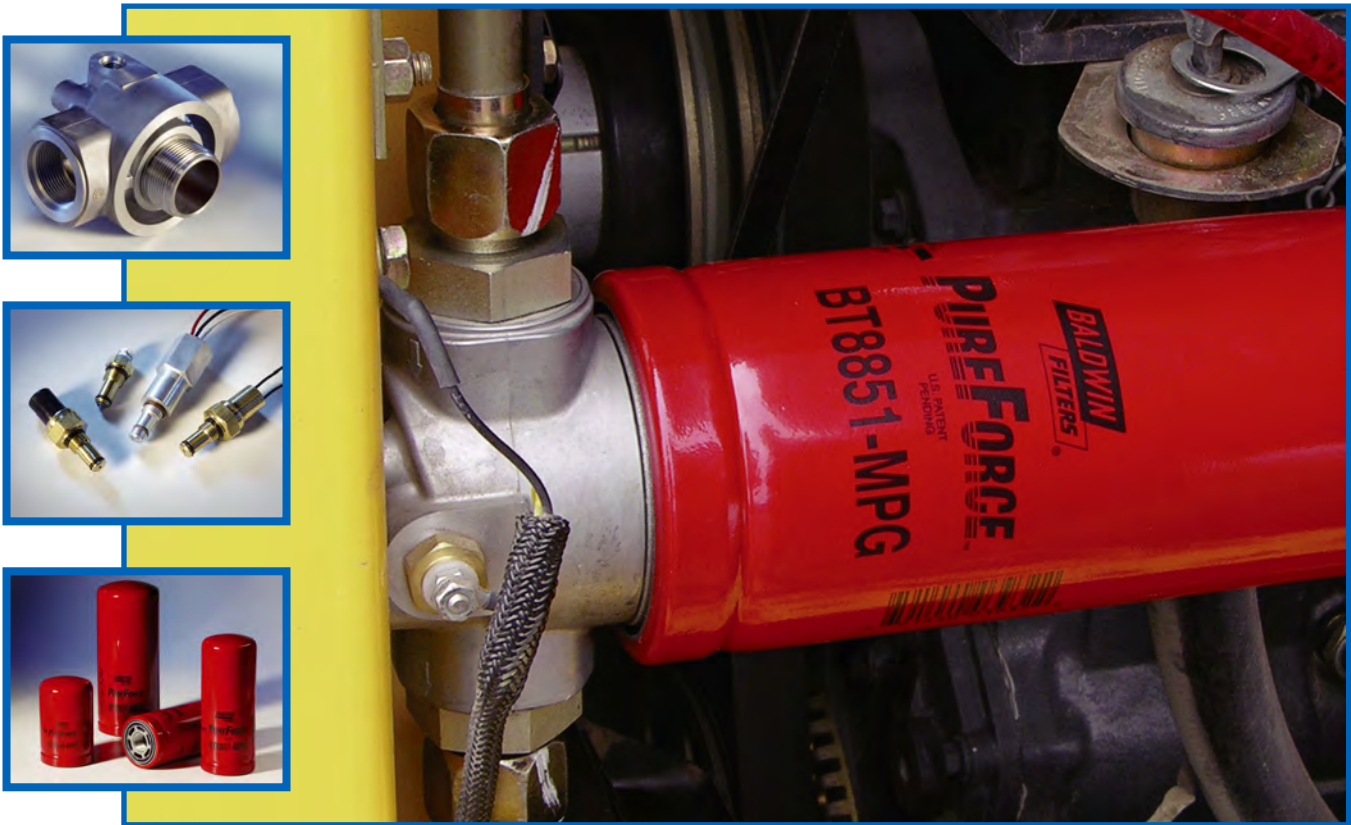

Taking Hydraulic System Reliability To A Higher Level



PUREFORCE Hydraulic Filtration Product Line



PureForce® Product Line Provides Superior Protection

With increased demands on today's hydraulic systems, maintaining system cleanliness through proper filtration is essential to insure reliability and lower maintenance costs. To maintain system cleanliness, Baldwin Filters introduces its PureForce hydraulic filtration product line.

Baldwin's PureForce product line brings many advantages, including the ability to consistently outperform the competition.

When Baldwin Filters' engineers designed the PureForce line, they examined the leading offerings and then designed a better product. These products were then subjected to rigorous lab and field testing.

Tests prove the PureForce filters perform more consistently than the leading competitor. In fatigue testing, involving cycling from zero to full operating pressure twice per second, the PureForce design, on average, lasted 30% longer than the leading competitor.

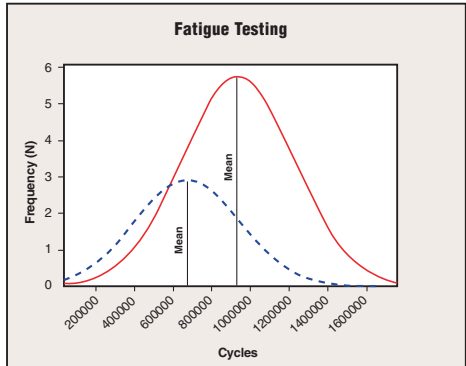

In burst testing, where filters were subjected to gradually increasing pressure until they failed, the PureForce Filters withstood 7% greater pressure than competitive filters and exceeded published specifications by 65%.

In comparative testing of the bases, the by-pass hysteresis is significantly reduced in the Baldwin design, minimizing the by-pass flow of unfiltered fluid. The consistent protection provided by the PureForce 4-inch and 5-inch bases helps maintain desired ISO fluid cleanliness levels.

The combination of Baldwin PureForce filters, bases and indicators offers superior protection for your sensitive hydraulic systems.

The PureForce product line allows users to customize filtration system to meet their needs by using a combination of bases, indicators and a selection of quality Baldwin hydraulic filters.

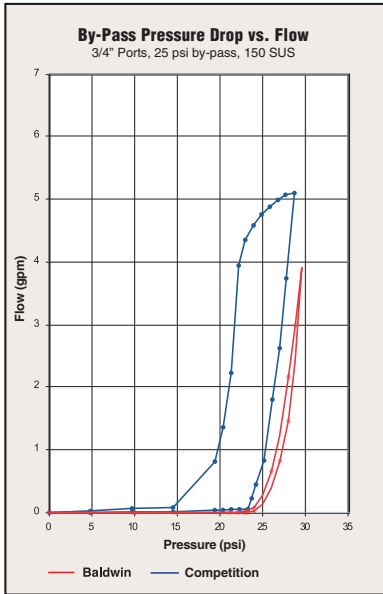

3" PureForce Filters

Filters

Length	O.D.	$\beta_{s(e)}=75$	$\beta_{s(e)}=1000$	Media Type	Part Number
5 1/2 (140.5)	3 1/8 (79.4)	9	14	MPG	BT9349-MPG
5 1/2 (140.5)	3 1/8 (79.4)	5	10	MPG	BT9393-MPG
5 1/2 (140.5)	3 1/8 (79.4)	25	30	Cellulose	BT8333
9 1/2 (241.3)	3 1/8 (79.4)	9	14	MPG	BT8886-MPG
9 1/2 (241.3)	3 1/8 (79.4)	5	10	MPG	BT9392-MPG
9 1/2 (241.3)	3 1/8 (79.4)	25	30	Cellulose	BT8418

Standard Thread = 2"-12 Measurements are shown in Inches and (Millimeters).

Performance Data

5.5" - 9.5" Filters (MPG Media)

(Pressure Drop = Combination of Filter & OE Base)

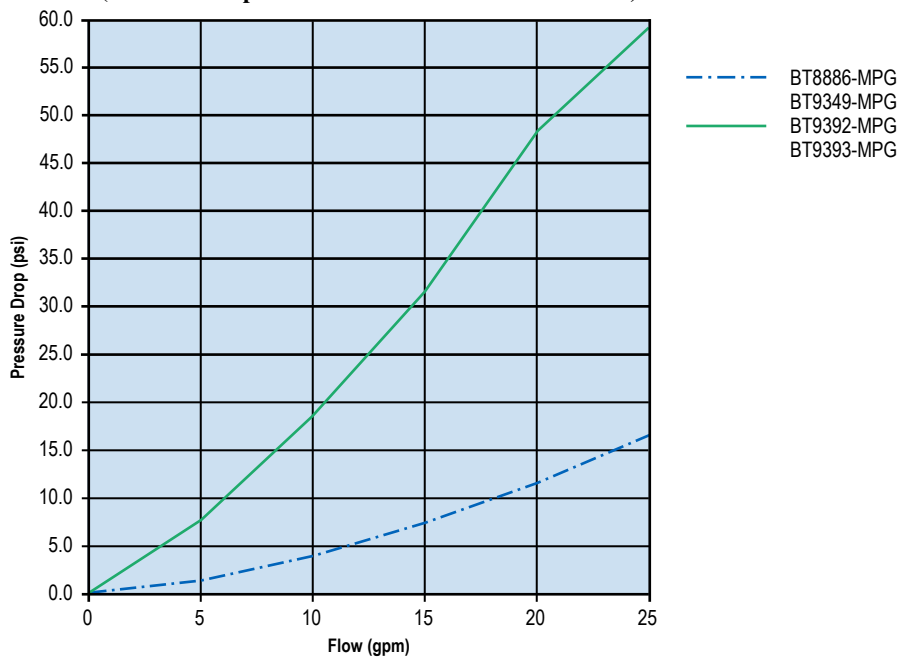

5.5" - 9.5" Filters (Cellulose Media)

(Pressure Drop = Combination of Filter & OE Base)

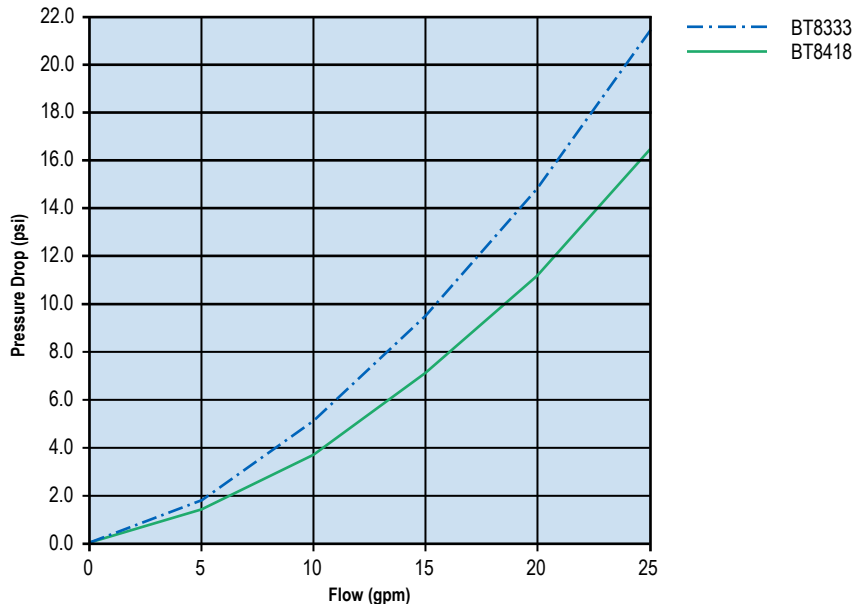

Side View 3" Filters

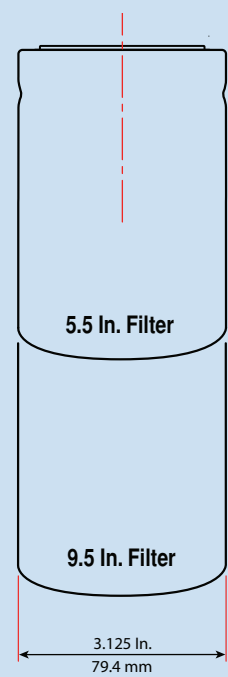

PUREFORCE

All tests used hydraulic fluid with a viscosity of 32 CST.

4" PureForce Bases and Filters

Bases

Top View 4" Base

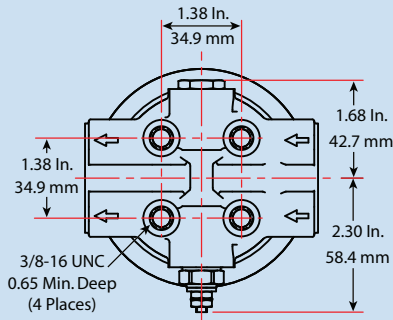

Side View 4" Base with Filters

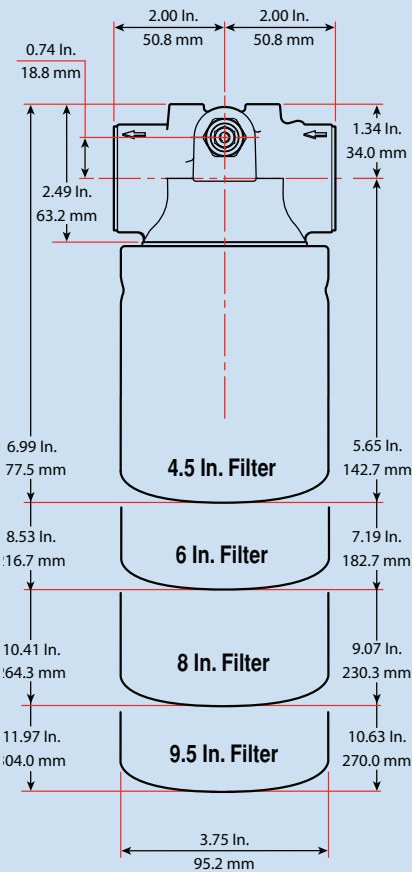

Inlet/Outlet	Threaded Stud	By-Pass	Indicator	Part Number
3/4" NPT	1 3/8"-12	25 psi	None	OB8711
3/4" NPT	1 3/8"-12	25 psi	25 psi Visual (Left Side)	OB8712
3/4" SAE O-Ring	1 3/8"-12	None	None	OB8720*
3/4" SAE O-Ring	1 3/8"-12	25 psi	None	OB8721
3/4" SAE O-Ring	1 3/8"-12	25 psi	25 psi Visual (Left Side)	OB8722
3/4" SAE O-Ring	1 3/8"-12	50 psi	None	OB8724
3/4" SAE O-Ring	1 3/8"-12	50 psi	50 psi DC Single-Post	OB8726
1" NPT	1 3/8"-12	25 psi	None	OB8731
1" NPT	1 3/8"-12	25 psi	25 psi Visual (Left Side)	OB8732
1" SAE O-Ring	1 3/8"-12	None	None	OB8740*
1" SAE O-Ring	1 3/8"-12	25 psi	None	OB8741
1" SAE O-Ring	1 3/8"-12	25 psi	25 psi Visual (Left Side)	OB8742
1" SAE O-Ring	1 3/8"-12	25 psi	25 psi DC Single-Post	OB8743
1" SAE O-Ring	1 3/8"-12	50 psi	None	OB8744
1" SAE O-Ring	1 3/8"-12	50 psi	50 psi Visual (Left Side)	OB8745
1" SAE O-Ring	1 3/8"-12	50 psi	50 psi DC Single-Post	OB8746

For Indicator Port Plug, Order OP8709. * Not Intended for Indicator Use.

Filters

Length	O.D.	$\beta_{x(c)}=75$	$\beta_{x(c)}=1000$	Media Type	Part Number
4 1/2 (114.3)	3 3/4 (95.3)	40	>50	MPG	BT9398-MPG
4 1/2 (114.3)	3 3/4 (95.3)	25	30	Cellulose	BT8416
6 (152.4)	3 3/4 (95.3)	17	25	MPG	BT732*
6 (152.4)	3 3/4 (95.3)	17	25	MPG	BT8426-MPG*
6 (152.4)	3 3/4 (95.3)	17	25	MPG	BT8439-MPG*
6 (152.4)	3 3/4 (95.3)	40	>50	MPG	BT8463-MPG
6 (152.4)	3 3/4 (95.3)	9	14	MPG	BT8840-MPG
6 (152.4)	3 3/4 (95.3)	17	25	MPG	BT8841-MPG
6 (152.4)	3 3/4 (95.3)	7	10	MPG	BT8842-MPG
6 (152.4)	3 3/4 (95.3)	17	25	MPG	BT8843-MPG*
6 (152.4)	3 3/4 (95.3)	5	10	MPG	BT8849-MPG
6 (152.4)	3 3/4 (95.3)	17	25	MPG	BT8904-MPG
6 (152.4)	3 3/4 (95.3)	17	25	MPG	BT9436-MPG
6 (152.4)	3 3/4 (95.3)	18	35	Cellulose	BT8464
6 (152.4)	3 3/4 (95.3)	25	30	Cellulose	BT8844*
6 (152.4)	3 3/4 (95.3)	25	30	Cellulose	BT8845
6 (152.4)	3 3/4 (95.3)	17	25	Cellulose	BT8846
6 (152.4)	3 3/4 (95.3)	45	>50	Cellulose	BT8847
6 (152.4)	3 3/4 (95.3)	25	30	Cellulose	BT9364
7 1/4 (184.2)	3 3/4 (95.3)	7	10	MPG	BT9400-MPG**
8 (203.4)	3 3/4 (95.3)	9	14	MPG	BT8848-MPG
8 (203.4)	3 3/4 (95.3)	17	25	Cellulose	BT9422
9 1/2 (241.3)	3 3/4 (95.3)	17	40	MPG	BT8466-MPG
9 1/2 (241.3)	3 3/4 (95.3)	8	18	MPG	BT8834-MPG
9 1/2 (241.3)	3 3/4 (95.3)	17	25	MPG	BT8850-MPG
9 1/2 (241.3)	3 3/4 (95.3)	9	14	MPG	BT8851-MPG
9 1/2 (241.3)	3 3/4 (95.3)	17	25	MPG	BT8852-MPG*
9 1/2 (241.3)	3 3/4 (95.3)	7	10	MPG	BT8853-MPG
9 1/2 (241.3)	3 3/4 (95.3)	5	10	MPG	BT8855-MPG
9 1/2 (241.3)	3 3/4 (95.3)	9	14	MPG	BT8856-MPG*
9 1/2 (241.3)	3 3/4 (95.3)	9	14	MPG	BT9363-MPG
9 1/2 (241.3)	3 3/4 (95.3)	7	10	MPG	BT9366-MPG
9 1/2 (241.3)	3 3/4 (95.3)	9	14	MPG	BT9370-MPG
9 1/2 (241.3)	3 3/4 (95.3)	40	>50	Cellulose	BT8312
9 1/2 (241.3)	3 3/4 (95.3)	40	>50	Cellulose	BT8465*
9 1/2 (241.3)	3 3/4 (95.3)	17	25	Cellulose	BT8861
9 1/2 (241.3)	3 3/4 (95.3)	25	30	Cellulose	BT8862
9 1/2 (241.3)	3 3/4 (95.3)	25	30	Cellulose	BT8863*
9 1/2 (241.3)	3 3/4 (95.3)	---	---	SS Mesh	BT9433*

Standard Thread = 1 3/8"-12 ▲ Heavy-Duty Centertube ✦ Thread = 2"-16 ● Thread = 13/16"-16

▼ Thread = 7/8"-14 ◆ High Capacity Version ■ 50 psi By-pass ‡ M24x1.5 Male Stud Fitting ◆ 140 Micron

Measurements are shown in Inches and (Millimeters).



Performance Data

4" Base Only

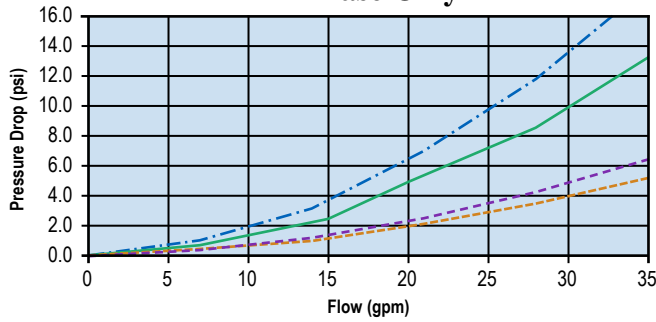

- 3/4" Ports w/25 psi by-pass
- 3/4" Ports w/o by-pass
- 1" Ports w/25 psi by-pass
- 1" Ports w/o by-pass

Maximum Working Pressures to:
500 psi / 3450 kPa / 34.5 bar

Minimum Rated Static Burst to:
1000 psi / 6900 kPa / 69.0 bar

Flow Range to:
35 gpm / 132 lpm

Porting Sizes
3/4" NPT
3/4" SAE O-Ring
1" NPT
1" SAE O-Ring

Replacement Filters Lengths
4.5"
6"
8"
9 1/2"

Standard By-Pass Ratings
None
25 psi
50 psi

Operating Temperatures
Cellulose:
-20 to 225°F / -29 to 107°C
MPG:
-20 to 250°F / -29 to 121°C

Collapse Ratings (Minimum)
150 psi / 1035 kPa / 10.4 bar

Housing Fatigue Strength Ratings
100,000 Cycles:
0-500 psid / 0-3450 kPa / 34.5 bar
300,000 Cycles:
0-400 psid / 0-2758 kPa / 27.6 bar
1,000,000 Cycles:
0-350 psid / 0-2415 kPa / 24.2 bar

4.5" - 8" Filters (MPG Media)

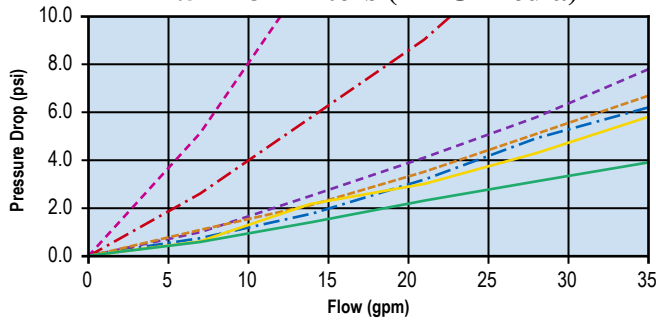

- BT732
- BT8463-MPG
- BT8840-MPG
- BT8426-MPG
- BT8439-MPG
- BT8841-MPG
- BT8843-MPG
- BT8904-MPG
- BT9436-MPG
- BT8842-MPG
- BT9400-MPG
- BT8848-MPG
- BT8849-MPG

4.5" - 8" Filters (Cellulose Media)

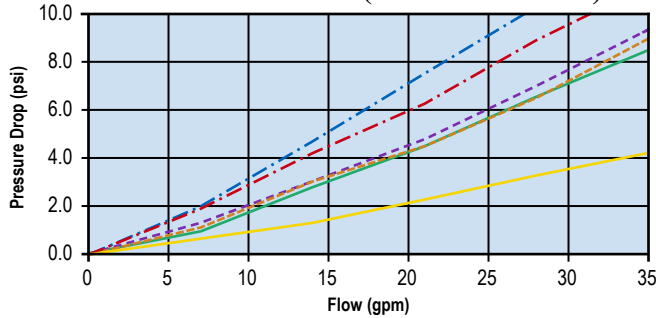

- BT8416
- BT8464
- BT8844
- BT8845
- BT9364
- BT8846
- BT9422
- BT8847

9.5" Filters (MPG Media)

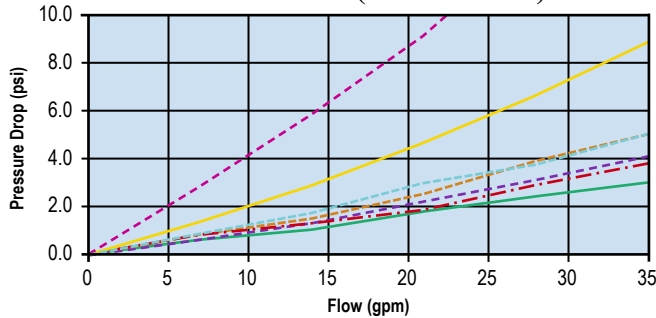

- BT8466-MPG
- BT8834-MPG
- BT8850-MPG
- BT8851-MPG
- BT8852-MPG
- BT8853-MPG
- BT8855-MPG
- BT8856-MPG

9.5" Filters (Cellulose Media)

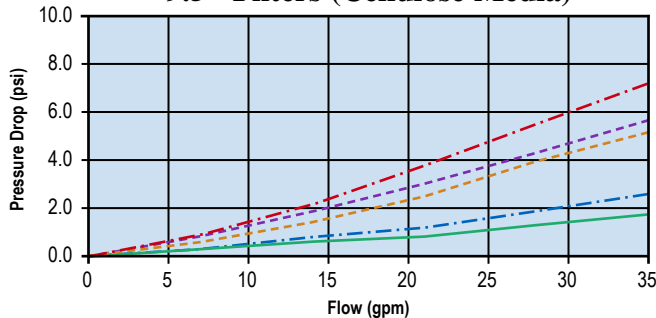

- BT8312
- BT8465
- BT8861
- BT8862
- BT8863

All tests used hydraulic fluid with a viscosity of 32 CST.



5" PureForce Bases and Filters

Bases

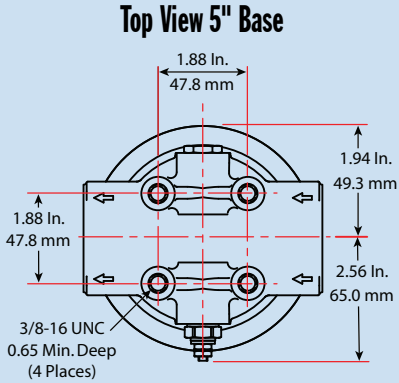

Inlet/Outlet	Threaded Stud	By-Pass	Indicator	Part Number
1 1/4" NPT	1 3/4"-12	25 psi	None	OB8771
1 1/4" NPT	1 3/4"-12	25 psi	25 psi Visual (Left Side)	OB8772
1 1/4" NPT	1 3/4"-12	25 psi	25 psi DC Single-Post	OB8773
1 1/4" SAE O-Ring	1 3/4"-12	25 psi	None	OB8781
1 1/4" SAE O-Ring	1 3/4"-12	25 psi	25 psi Visual (Left Side)	OB8783

For Indicator Port Plug, Order OP8709.

Filters

Length	O.D.	$\beta_{x(c)}=75$	$\beta_{x(c)}=1000$	Media Type	Part Number
8 (203.2)	4 3/4 (120.7)	17	25	MPG	BT8875-MPG
8 (203.2)	4 3/4 (120.7)	9	14	MPG	BT8880-MPG
11 1/2 (292.1)	4 3/4 (120.7)	18	23	MPG	BT8401-MPG
11 1/2 (292.1)	4 3/4 (120.7)	10	15	MPG	BT8432-MPG ⁺
11 1/2 (292.1)	4 3/4 (120.7)	9	14	MPG	BT8874-MPG
11 1/2 (292.1)	4 3/4 (120.7)	17	25	MPG	BT8876-MPG
11 1/2 (292.1)	4 3/4 (120.7)	5	10	MPG	BT8877-MPG
11 1/2 (292.1)	4 3/4 (120.7)	7	10	MPG	BT8878-MPG
11 1/2 (292.1)	4 3/4 (120.7)	9	14	MPG	BT8879-MPG
11 1/2 (292.1)	4 3/4 (120.7)	40	>50	MPG	BT8892-MPG
11 1/2 (292.1)	4 3/4 (120.7)	17	25	MPG	BT8910-MPG
11 1/2 (292.1)	4 3/4 (120.7)	7	10	MPG	BT8911-MPG
11 1/2 (292.1)	4 3/4 (120.7)	7	10	MPG	BT9353-MPG
11 1/2 (292.1)	4 3/4 (120.7)	7	10	MPG	BT9362-MPG ⁺
11 1/2 (292.1)	4 3/4 (120.7)	9	14	MPG	BT9365-MPG
11 1/2 (292.1)	4 3/4 (120.7)	9	14	MPG	BT9391-MPG ⁺
11 1/2 (292.1)	4 3/4 (120.7)	9	14	MPG	BT9421-MPG ⁺
11 1/2 (292.1)	4 3/4 (120.7)	20	26	Cellulose	BT8320 ⁺
11 1/2 (292.1)	4 3/4 (120.7)	25	30	Cellulose	BT8873
14 (355.6)	4 3/4 (120.7)	9	14	MPG	BT8870-MPG
14 (355.6)	4 3/4 (120.7)	7	10	MPG	BT9560-MPG

Standard Thread = 1 3/4"-12

◆ High Capacity Version ✦ 4" L-Lock Interface; Thread = 1 3/8"-12

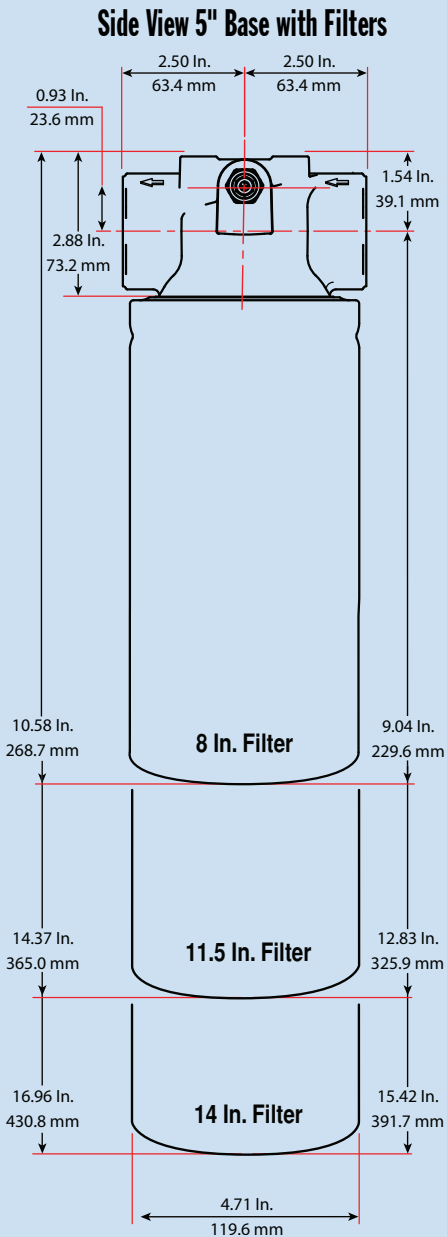

Performance Data

5" Base Only

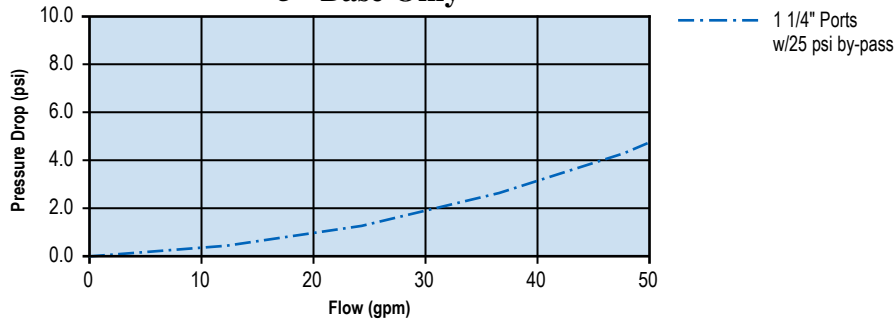

8" Filters (MPG Media)

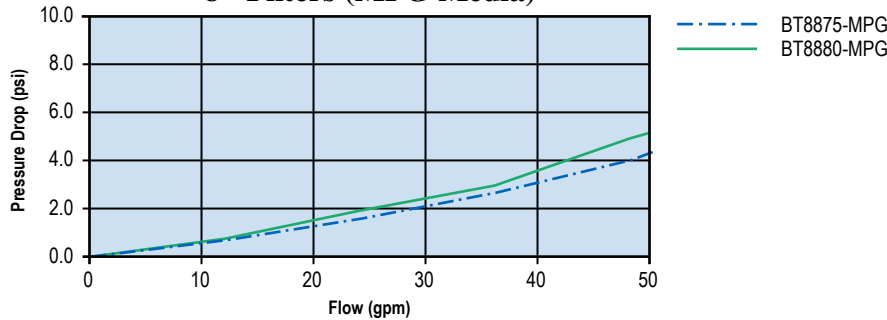

11.5" Filters (MPG Media)

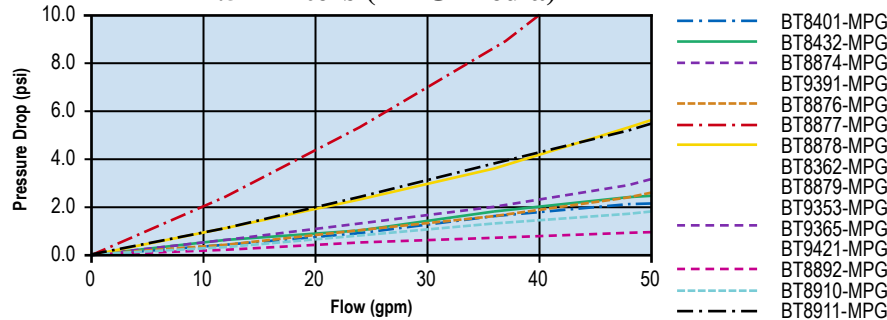

11.5" Filters (Cellulose Media)

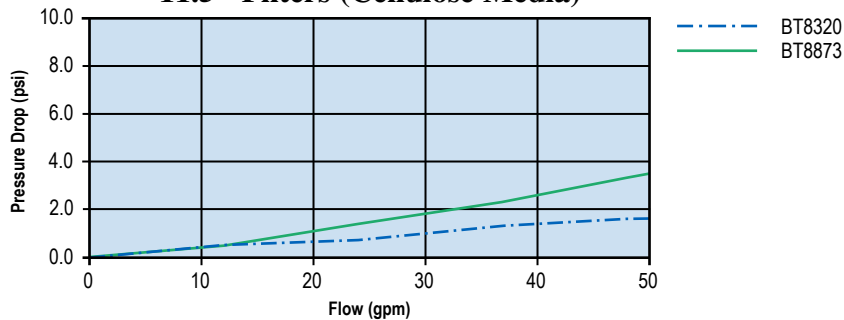

14" Filters (MPG Media)

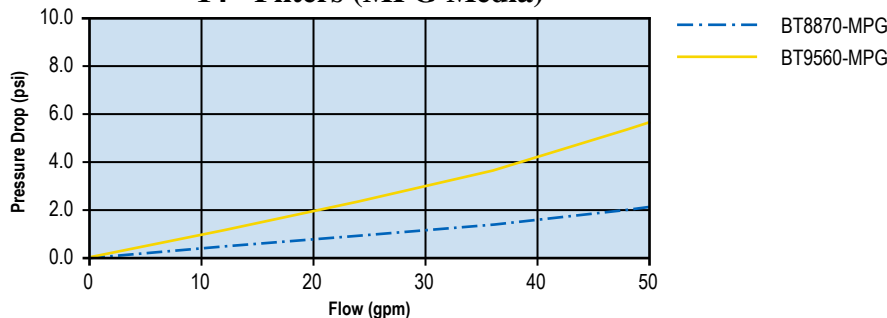

All tests used hydraulic fluid with a viscosity of 32 CST.

Maximum Working Pressures to:

350 psi / 2400 kPa / 24.0 bar

Minimum Rated Static Burst to:

800 psi / 5500 kPa / 55.0 bar

Flow Range to:

50 gpm / 189 lpm

Porting Sizes

1 1/4" NPT
1 1/4" SAE O-Ring

Replacement Filters Lengths

8"
11 1/2"
14"

Standard By-Pass Ratings

None
25 psi
50 psi (Special Order)

Operating Temperatures

Cellulose:
-20 to 225°F / -29 to 107°C

MPG:
-20 to 250°F / -29 to 121°C

Collapse Ratings (Minimum)

200 psi / 1380 kPa / 13.8 bar

Housing Fatigue Strength Ratings

100,000 Cycles:
0-350 psid / 0-2413 kPa / 24.1 bar

300,000 Cycles:
0-300 psid / 0-2068 kPa / 20.7 bar

1,000,000 Cycles:
0-250 psid / 0-1734 kPa / 17.3 bar



Switch Set Point

35 +/-5 psid
15 +/-5 psid

Operating Pressure

1000 psid

Operating Temperatures

-20 to 250°F
-29 to 121°C

Installation Torque (Maximum)

10 Ft./Lbs.

Single-Post

Electrical Ratings (Maximum)

Contact Rating 10 VA
Switching Current 0.5 A
Carry Current 1.0 A
DC Switching Voltage 100 VDC

2-Wire

Electrical Ratings (Maximum)

Contact Rating 10 VA
Switching Current 0.5 A
Carry Current 1.0 A
DC Switching Voltage 100 VDC
AC Switching Voltage 100 VAC RMS
Contact Resistance 300 Milliohms

3-Wire

Electrical Ratings (Maximum)

2 amps @ 24 VDC
2 amps @ 110 VAC

Visual Indicators

Use With By-Pass Valve Pressure of:	Logic	Description	Use With	Part Number
25 psi	N/A	Pop-Up Button	PureForce Bases	OV8700
50 psi	N/A	Pop-Up Button	PureForce Bases	OV8701

Electrical Indicators

Use With By-Pass Valve Pressure of:	Logic	Description	Use With	Part Number
25 psi	N.O.	DC Single-Post	PureForce Bases	OS8704
50 psi	N.O.	DC Single-Post	PureForce Bases	OS8705
25 psi	N.C.	DC Single-Post	PureForce Bases	OS8717
50 psi	N.C.	DC Single-Post	PureForce Bases	OS8718
25 psi	N.O.	AC/DC 2-Wire	PureForce Bases	OS8702
50 psi	N.O.	AC/DC 2-Wire	PureForce Bases	OS8703
25 psi	Both	AC/DC 3-Wire White - Normally Open Red - Normally Closed Black - Common	PureForce Bases	OS8706
50 psi	Both	AC/DC 3-Wire White - Normally Open Red - Normally Closed Black - Common	PureForce Bases	OS8707

N.O. = Normally Open. N.C. = Normally Closed.

Port Plug

For Indicator Port Plug, Order OP8709.

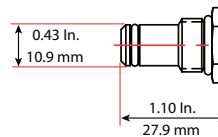

Switch Logic

Normally Open Single-Post

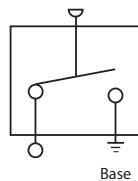

Normally Closed Single-Post

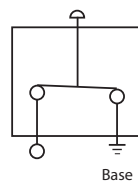

Normally Open 2-Wire

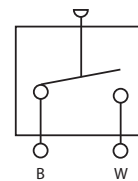

Normally Open 3-Wire

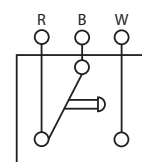

BALDWIN FILTERS®

a CLARCOR company

4400 East Highway 30 ■ P.O. Box 6010

Kearney, Nebraska 68848-6010

Phone: (308) 234-1951 ■ Toll Free: (800) 822-5394

Fax: (800) 828-4453 ■ Int'l Fax: (308) 237-9769

Internet: www.baldwinfilter.com



PUREFORCE®